

CERTIFIED PERFORMANCE DATA
Testing Information:

All acoustical performance and aerodynamic data is derived from NVLAP accredited laboratory tests in accordance with ASTM E477, the standard method for testing duct silencers. Published information originated from a 24"x24" (610mm x 610mm) production unit, tested in forward flow ("+" = air/noise in same direction) and reverse flow ("-") = air/noise in opposite direction). If silencers are installed immediately before/after elbows or transitions, at the intake/discharge of the system or without a duct, allowance for such conditions must be included and compensated for when calculating the operating pressure through the silencer. Failure to make allowances for these conditions can add several velocity heads to the pressure loss of the system.

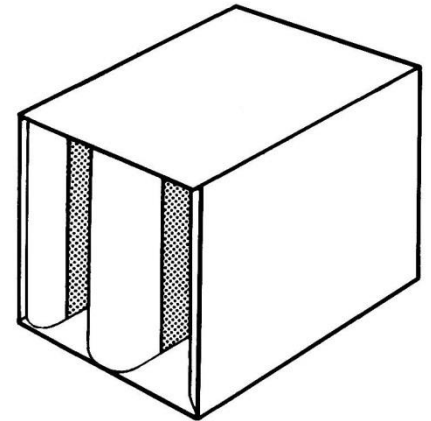

Model	Face Velocity fpm	Insertion Loss (db)							
		Octave Band Center Frequency (Hz)							
		1 63	2 125	3 250	4 500	5 1K	6 2K	7 4K	8 8K
3B2-MR	-1500	3	4	9	17	25	25	11	9
	-1000	4	4	8	17	25	25	11	9
	+1000	2	3	9	16	24	26	18	12
	+2000	1	2	9	16	23	26	18	11
5B2-MR	-1500	3	5	15	34	46	35	17	13
	-1000	4	5	14	33	46	35	17	13
	+1000	4	4	13	30	43	37	21	13
	+2000	3	4	12	28	41	38	21	13
7B2-MR	-1500	3	6	18	44	49	43	18	11
	-1000	3	5	17	42	50	45	19	12
	+1000	3	5	15	37	53	46	24	15
	+2000	2	4	14	35	52	47	25	15
10B2-MR	-1500	8	10	25	53	59	58	34	24
	-1000	7	9	24	52	60	60	34	24
	+1000	6	8	23	46	60	60	37	23
	+2000	5	9	23	45	60	60	38	23

This table contains forward and reverse flow acoustic performance data based on testing to ASTM E477 testing standards. Copies of these tests can be furnished upon request.

Standard Construction:

- Maximum Differential Pressure: 8 in. wg.
- Outer casing: Minimum 22 gauge G90 galvanized steel
- Internal baffles: Minimum 22 gauge G90 galvanized steel
- Lock formed and mastic filled
- Attenuation materials: Mold Resistance, all natural fiber that has been treated with an EPA registered anti-microbial agent for protection against mildew, fungi, pests and mold. Meets UL 723, ASTM E84.



AIR FLOW RATINGS FOR THE 12"x12" SIZE, (SHADED), INDICATES CFM AND FACE VELOCITY IN FPM. USE THIS 12"x12" VALUES TO CALCULATE THE RATING FOR SILENCER SIZES NOT SHOWN AND FOR MULTIPLE MODULE SILENCER BANKS.

MODEL	3B2-MR	0.05	0.10	0.15	0.20	0.29	0.40	0.50	0.60	0.75	0.90	1.00	1.10
	5B2-MR	0.07	0.13	0.20	0.27	0.41	0.56	0.70	0.84	1.05	1.27	1.41	1.55
	7B2-MR	0.07	0.14	0.21	0.30	0.45	0.62	0.78	0.94	1.17	1.41	1.56	1.72
	10B2-MR	0.10	0.20	0.30	0.46	0.69	0.94	1.17	1.41	1.76	2.11	2.35	2.58
SIZE W x H	FACE AREA	AIR FLOW IN CFM											
6 x 12	0.50	457	646	791	976	1195	1398	1563	1712	1914	2097	2210	2318
6 x 24	1.00	913	1291	1581	1952	2390	2795	3125	3423	3827	4193	4419	4635
6 x 36	1.50	1370	1937	2372	2928	3585	4193	4688	5135	5741	6290	6629	6953
12 x 12	1.00	913	1291	1581	1952	2390	2795	3125	3423	3827	4193	4419	4635
12 x 24	2.00	1826	2582	3162	3904	4780	5590	6250	6846	7654	8386	8838	9270
12 x 36	3.00	2739	3873	4743	5856	7170	8385	9375	10269	11481	12579	13257	13905
18 x 12	1.50	1370	1937	2372	2928	3585	4193	4688	5135	5741	6290	6629	6953
18 x 18	2.25	2054	2905	3557	4392	5378	6289	7031	7702	8611	9434	9943	10429
18 x 30	3.75	3424	4841	5929	7320	8963	10481	11719	12836	14351	15724	16571	17381
18 x 36	4.50	4109	5810	7115	8784	10755	12578	14063	15404	17222	18869	19886	20858
18 x 48	6.00	5478	7746	9486	11712	14340	16770	18750	20538	22962	25158	26514	27810
24 x 24	4.00	3652	5164	6324	7808	9560	11180	12500	13692	15308	16772	17676	18540
24 x 36	6.00	5478	7746	9486	11712	14340	16770	18750	20538	22962	25158	26514	27810
24 x 48	8.00	7304	10328	12648	15616	19120	22360	25000	27384	30616	33544	35352	37080
30 x 24	5.00	4565	6455	7905	9760	11950	13975	15625	17115	19135	20965	22095	23175
30 x 36	7.50	6848	9683	11858	14640	17925	20963	23438	25673	28703	31448	33143	34763
30 x 48	10.00	9130	12910	15810	19520	23900	27950	31250	34230	38270	41930	44190	46350
36 x 36	9.00	8217	11619	14229	17568	21510	25155	28125	30807	34443	37737	39771	41715
36 x 42	10.50	9587	13556	16601	20496	25095	29348	32813	35942	40184	44027	46400	48668
36 x 48	12.00	10956	15492	18972	23424	28680	33540	37500	41076	45924	50316	53028	55620

SELF GENERATED SOUND POWER RATINGS (PWL) dB RE 10⁻¹² watts

OCTAVE BAND		1	2	3	4	5	6	7	8
[HZ]		63	125	250	500	1K	2K	4K	8K
MODEL	FACE VELOCITY [FPM]								
ALL LENGTHS	+2000	60	55	51	47	45	50	48	43
	+1000	53	40	35	32	33	26	24	30
	-1000	52	42	40	42	40	37	28	30
	-1500	64	56	54	53	56	63	59	51

SELF GENERATED SOUND RATINGS FACE AREA-ADJUSTMENT FACTORS

FACE AREA [FT ²]	.50	1	2	4	8	10	32	64	128
PWL ADJUSTMENT FACTOR, [dB]	-9	-6	-3	0	+3	+6	+9	+12	+16

Version: 1-2014

