

CERTIFIED PERFORMANCE DATA
Testing Information:

All acoustical performance and aerodynamic data is derived from NVLAP accredited laboratory tests in accordance with ASTM E477, the standard method for testing duct silencers. Published information originated from a 24"x24" (610mm x 610mm) production unit, tested in forward flow ("+" = air/noise in same direction) and reverse flow ("-") = air/noise in opposite direction). If silencers are installed immediately before/after elbows or transitions, at the intake/discharge of the system or without a duct, allowance for such conditions must be included and compensated for when calculating the operating pressure through the silencer. Failure to make allowances for these conditions can add several velocity heads to the pressure loss of the system.

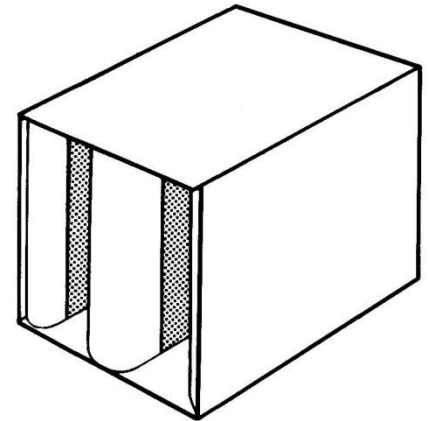

Model	Face Velocity fpm	Insertion Loss (db)							
		Octave Band Center Frequency (Hz)							
		1 63	2 125	3 250	4 500	5 1K	6 2K	7 4K	8 8K
3B4-LF	-2000	7	8	17	21	18	15	10	9
	-1000	6	8	17	20	18	14	11	10
	+1000	5	7	15	18	16	13	11	10
	+2000	4	6	15	17	15	12	10	10
5B4-LF	-2000	12	14	28	31	30	17	15	11
	-1000	11	14	27	30	29	17	15	12
	+1000	9	12	24	28	27	16	12	11
	+2000	8	12	23	27	26	17	12	12
7B4-LF	-2000	14	19	33	44	43	22	16	13
	-1000	15	18	32	44	42	21	16	15
	+1000	14	15	29	42	42	23	15	13
	+2000	14	15	27	40	42	23	16	14
10B4-LF	-2000	19	25	43	52	54	27	20	15
	-1000	18	24	42	52	54	28	22	16
	+1000	17	23	40	50	52	30	22	17
	+2000	17	22	38	49	51	30	23	18

This table contains forward and reverse flow acoustic performance data based on testing to ASTM E477 testing standards. Copies of these tests can be furnished upon request.

Standard Construction:

- Maximum Differential Pressure: 8 in. wg.
- Outer casing: Minimum 22 gauge G90 galvanized steel
- Internal baffles: Minimum 22 gauge G90 galvanized steel
- Lock formed and mastic filled
- Attenuation materials: Inorganic glass fiber packed under a minimum of 5% compression. Flame spread of 15, fuel contributed of 0, smoke developed of 0 as tested with UL Test Procedure 723



AIR FLOW RATINGS FOR THE 12"x12" SIZE, (SHADED), INDICATES CFM AND FACE VELOCITY IN FPM. USE THIS 12"x12" VALUES TO CALCULATE THE RATING FOR SILENCER SIZES NOT SHOWN AND FOR MULTIPLE MODULE SILENCER BANKS.

MODEL	3B4-LF	0.04	0.07	0.10	0.13	0.15	0.17	0.20	0.26	0.32	0.44	0.59	0.73
	5B4-LF	0.04	0.07	0.10	0.14	0.16	0.18	0.21	0.27	0.33	0.46	0.62	0.77
	7B4-LF	0.05	0.08	0.11	0.14	0.17	0.19	0.22	0.28	0.35	0.49	0.65	0.81
	10B4-LF	0.05	0.09	0.12	0.16	0.19	0.22	0.25	0.32	0.40	0.56	0.74	0.92
SIZE W x H	FACE AREA	AIR FLOW IN CFM											
6 x 12	0.50	227	297	354	402	438	465	500	569	630	743	858	959
6 x 24	1.00	454	594	707	804	875	930	1000	1138	1260	1485	1715	1917
6 x 36	1.50	681	891	1061	1206	1313	1395	1500	1707	1890	2228	2573	2876
12 x 12	1.00	454	594	707	804	875	930	1000	1138	1260	1485	1715	1917
12 x 24	2.00	908	1188	1414	1608	1750	1860	2000	2276	2520	2970	3430	3834
12 x 36	3.00	1362	1782	2121	2412	2625	2790	3000	3414	3780	4455	5145	5751
18 x 12	1.50	681	891	1061	1206	1313	1395	1500	1707	1890	2228	2573	2876
18 x 18	2.25	1022	1337	1591	1809	1969	2093	2250	2561	2835	3341	3859	4313
18 x 30	3.75	1703	2228	2651	3015	3281	3488	3750	4268	4725	5569	6431	7189
18 x 36	4.50	2043	2673	3182	3618	3938	4185	4500	5121	5670	6683	7718	8627
18 x 48	6.00	2724	3564	4242	4824	5250	5580	6000	6828	7560	8910	10290	11502
24 x 24	4.00	1816	2376	2828	3216	3500	3720	4000	4552	5040	5940	6860	7668
24 x 36	6.00	2724	3564	4242	4824	5250	5580	6000	6828	7560	8910	10290	11502
24 x 48	8.00	3632	4752	5656	6432	7000	7440	8000	9104	10080	11880	13720	15336
30 x 24	5.00	2270	2970	3535	4020	4375	4650	5000	5690	6300	7425	8575	9585
30 x 36	7.50	3405	4455	5303	6030	6563	6975	7500	8535	9450	11138	12863	14378
30 x 48	10.00	4540	5940	7070	8040	8750	9300	10000	11380	12600	14850	17150	19170
36 x 36	9.00	4086	5346	6363	7236	7875	8370	9000	10242	11340	13365	15435	17253
36 x 42	10.50	4767	6237	7424	8442	9188	9765	10500	11949	13230	15593	18008	20129
36 x 48	12.00	5448	7128	8484	9648	10500	11160	12000	13656	15120	17820	20580	23004

SELF GENERATED SOUND POWER RATINGS (PWL) dB RE 10⁻¹² watts

OCTAVE BAND		1	2	3	4	5	6	7	8
[HZ]		63	125	250	500	1K	2K	4K	8K
MODEL	FACE VELOCITY [FPM]								
ALL LENGTHS	+1500	55	54	59	57	53	55	54	49
	+1000	46	35	38	37	42	38	28	22
	-1000	47	42	41	44	46	45	36	28
	-1500	54	53	55	56	57	60	60	53

SELF GENERATED SOUND RATINGS FACE AREA-ADJUSTMENT FACTORS

FACE AREA [FT ²]	.50	1	2	4	8	10	32	64	128
PWL ADJUSTMENT FACTOR, [dB]	-9	-6	-3	0	+3	+6	+9	+12	+15

Version: 1-2014

